

エチレン誘導体

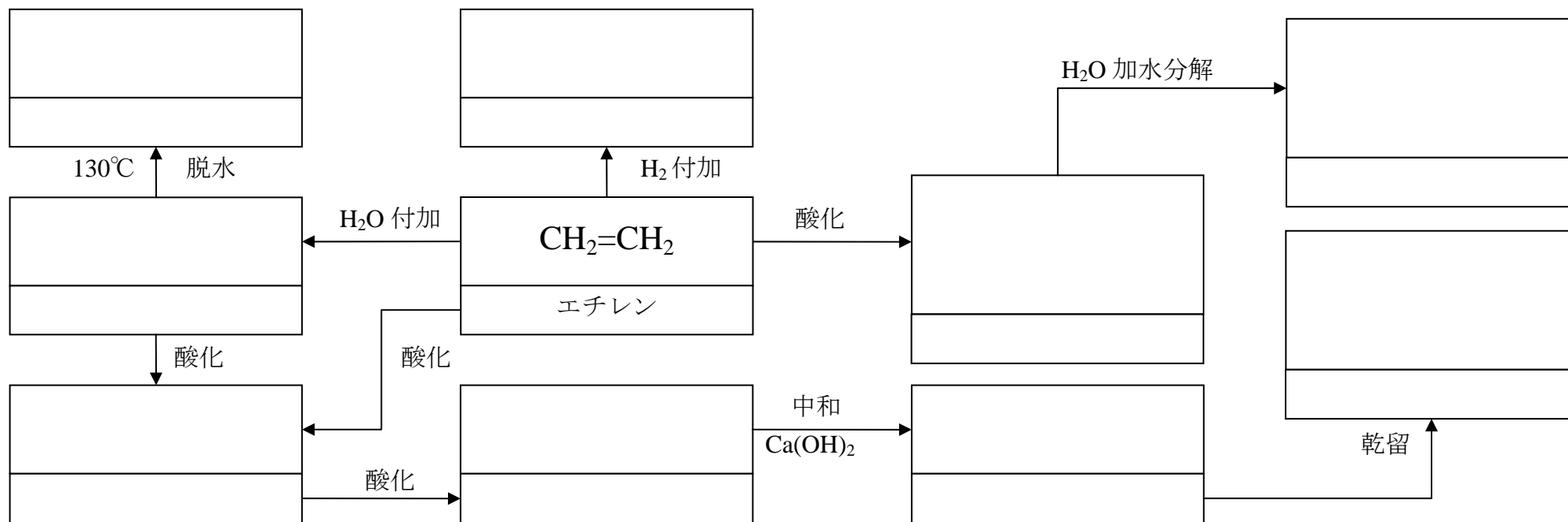

メタン誘導体

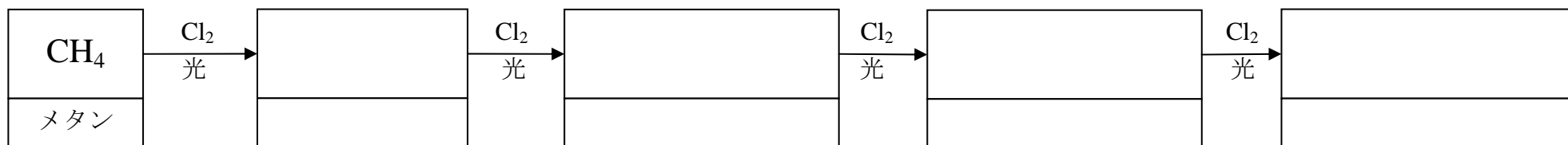

アセチレン誘導体 1

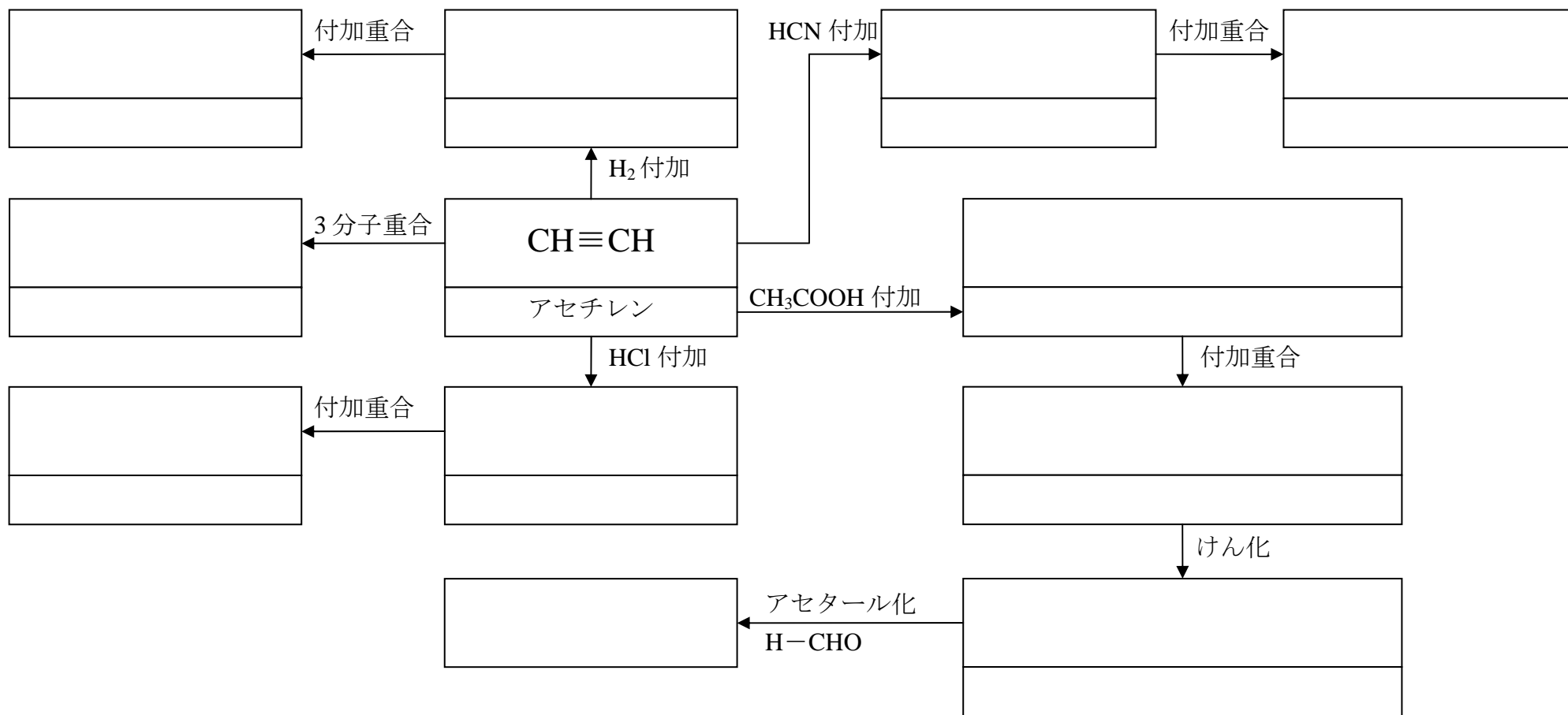

アセチレン誘導体 2

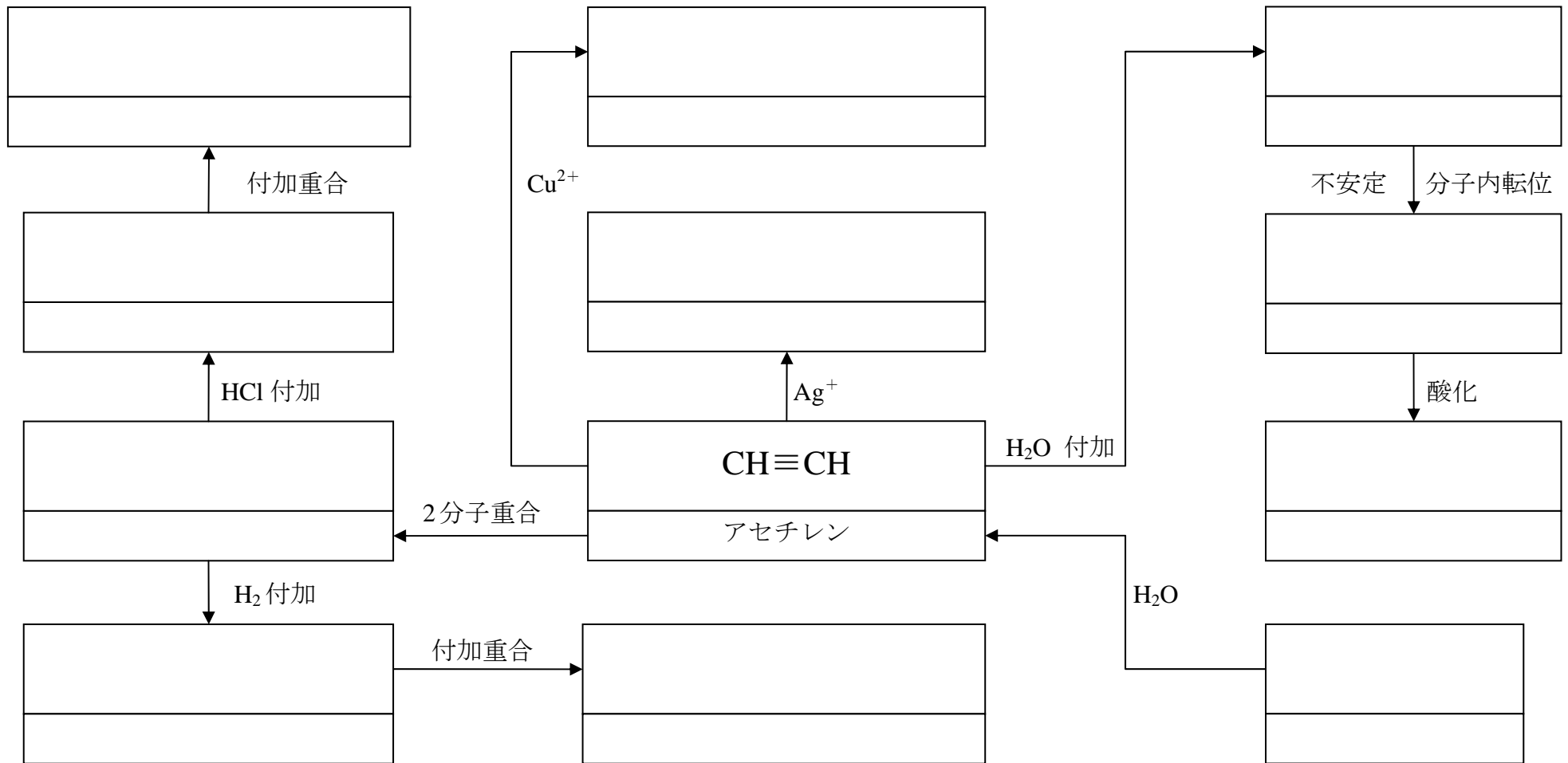

解答 エチレン誘導体

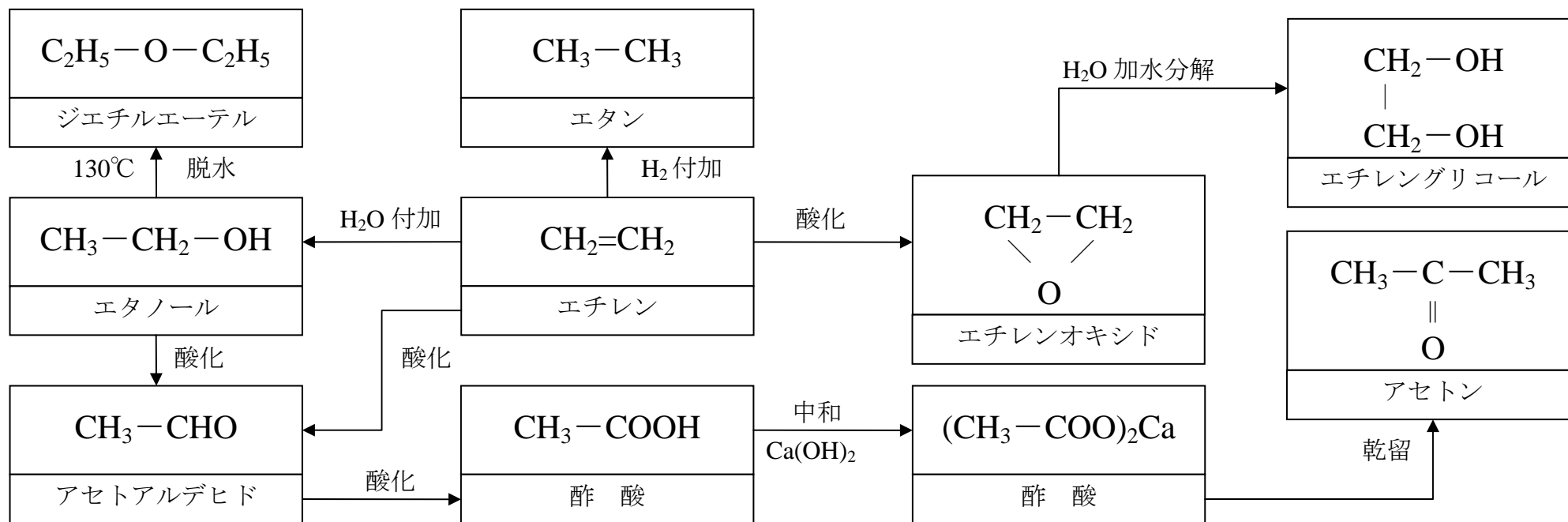

解答 メタン誘導体

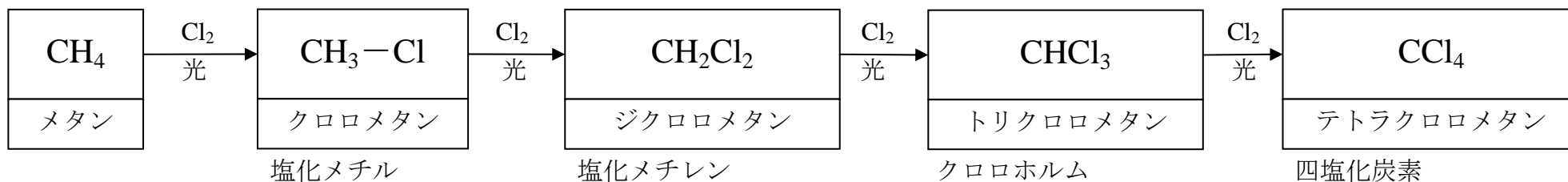

解答 アセチレン誘導体 1

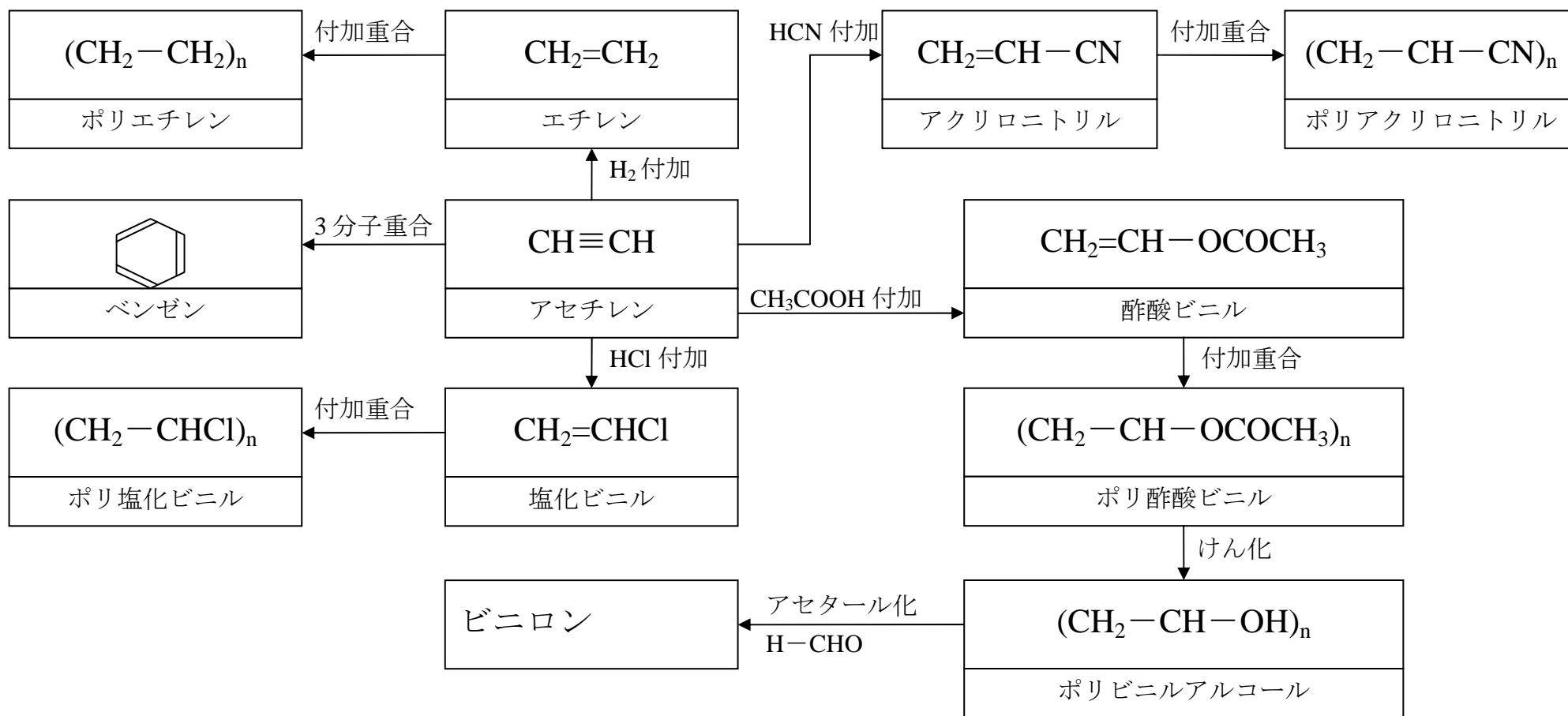

解答 アセチレン誘導体 2

